

Columns are available in different designs and sizes as shown in this catalog. It comes in two halves, with a center cut-out to fit your support post (4" x 4", 6" x 6", 4" diameter, 6" diameter, etc.). You must specify.

The two halves attach to the center support, into each other with liquid nails, Elmer's® or Henry's® panel adhesives. After that, it's ready for plaster.

The center (SHAFT) can be round or square, straight or tapered, smooth or fluted. The columns consist of three parts: CAPITALS (top part), SHAFT (center part) and BASE (bottom part). All parts are custom made to fit your requirements.

CUSTOMIZED FOAM DESIGN SHAPE TO FIT STRUCTURAL SUPPORT

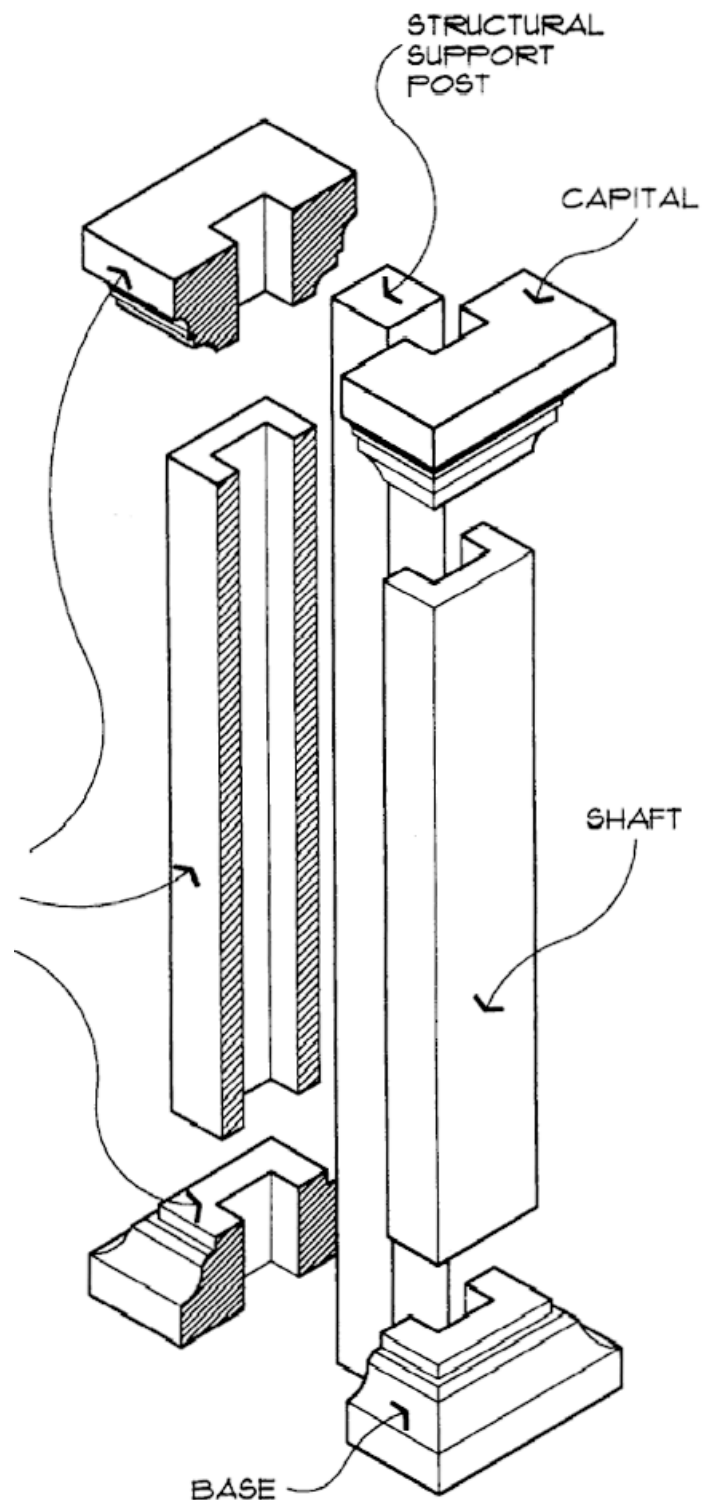

NOTE:
FOAM MAY BE BONDED DIRECTLY TO STRUCTURAL MEMBER OR TO GYPSUM-BOARD ENCLOSURE



12961 San Fernando Road • Sylmar, CA 91342
800.709.3626 or 818.833.4343 Fax 818.833.4545

CAPITALS

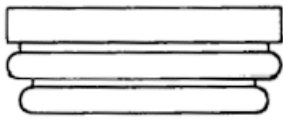

WF 3101

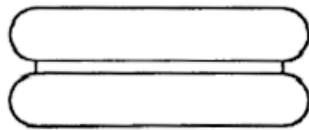

WF 3102

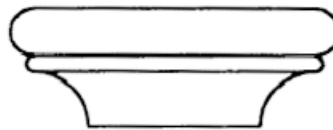

WF 3103

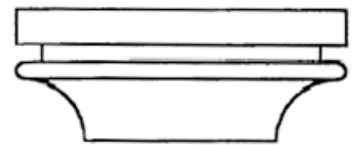

WF 3104

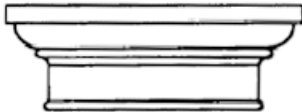

WF 3105

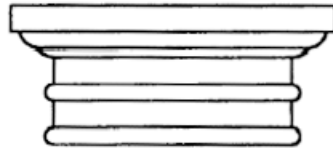

WF 3106

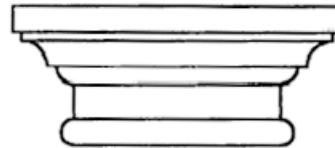

WF 3107

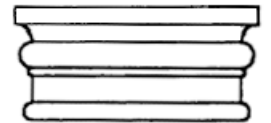

WF 3108

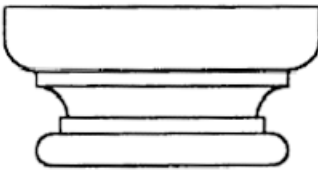

WF 3109

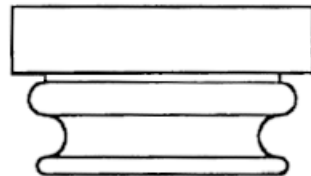

WF 3110

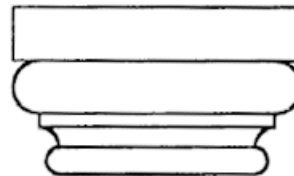

WF 3111

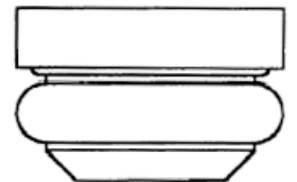

WF 3112

BASES

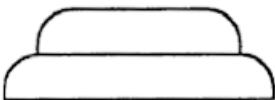

WF 3113

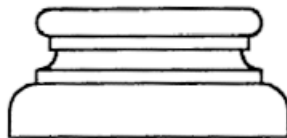

WF 3114

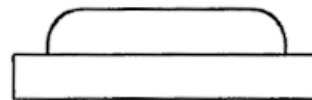

WF 3115

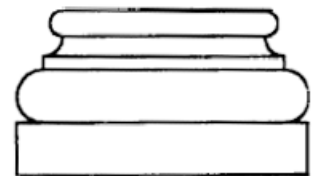

WF 3116

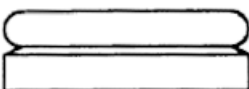

WF 3117

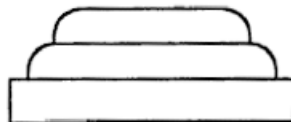

WF 3118

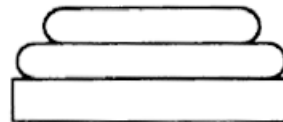

WF 3119

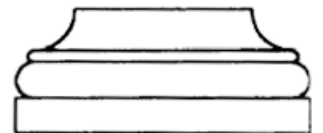

WF 3120

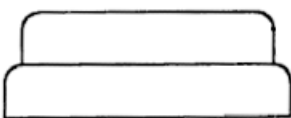

WF 3121

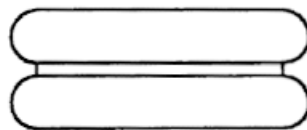

WF 3122

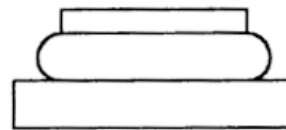

WF 3123

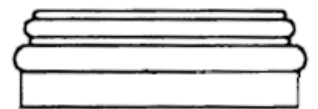

WF 3124

